



VLWP-2HVG-TR

18G, 2x1 HDMI/VGA Wall Plate w/Auto-Switching,
USB2.0, POC (2-Gang US Decora, 40M@4K, 70M@1080P)
White color Tx



User Manual

VER 1.0

Thank you for purchasing this product

Please read these instructions carefully for optimum performance and safety before connecting, operating, or adjusting this product. Please keep this manual for future reference.

A surge protection device is recommended.

This product contains sensitive electrical components that electrical spikes may damage, surges, electric shock, lightning strikes, etc. The use of surge protection systems is highly recommended to protect and extend the life of your equipment.

Table of Contents

1. Introduction.....	2
2. Features.....	2
3. Package Contents.....	2
4. Specifications.....	3
5. Operation Controls and Functions.....	4
5.1. Front Panel.....	4
5.2. Rear Panel.....	5
5.3. Side Panel.....	5
5.4. Dimension of the panel.....	6
6. Application Example.....	8

1. Introduction

The HDBaseT Wall-plate Transmitter supports HDMI and VGA with audio inputs within a standard 2-Gang US Decora wall box. It can transmit HDMI signal over CAT6/6a/7 to a distance up to 131ft/40m for 4K2K@60Hz (4:4:4) or 1080p60Hz up to 230ft/70m. Auto-switching allows users to plug in and play. Built-in two-way IR, RS-232, and USB transmissions for easy device control.

2. Features

- ☆ HDMI 2.0b 18Gbps, HDCP 2.2 compliant
- ☆ up to 4K2K@60Hz (4:4:4), 4K2K@30Hz, 1080p@120Hz
- ☆ up to 7.1 channels HD audio
- ☆ HDBaseT™ over a single CAT6/6a/7 cable up to 230ft/40m distance for 4K2K@60Hz (4:4:4) or up to 230ft/70m distance for 1080p60Hz
- ☆ Built-in scaling for VGA input
- ☆ Automatic and manual switching modes
- ☆ Two-way IR, RS-232, and USB supported
- ☆ 2-Gang US Decora Wall Plate
- ☆ 24V POC is supported

3. Package Contents

- ① 1× 18G HDMI Wall Plate Transmitter
- ② 1× Phoenix connector (3 pins)
- ③ 1× Phoenix connector (2 pins)
- ④ 1× Wideband IR RX
- ⑤ 1× Wideband IR TX
- ⑥ 1× User Manual

4. Specifications

Technical	
HDMI Compliance	HDMI 2.0b
HDCP Compliance	HDCP 2.2
Video Bandwidth	18 Gbps
HDMI Video Resolution	4K2K@50/60Hz 4:4:4 (max)
Color Space	RGB/YCbCr 4:4:4, YCbCr 4:2:2
Color Depth	10-bit, 12-bit
HDMI Audio Formats	LPCM, Dolby Digital/Plus/EX, Dolby True HD, DTS, DTS-EX, DTS-96/24, DTS High Res, DTS-HD Master Audio, DSD
VGA Video Resolution	1080P@50/60Hz 4:4:4 (max)
ESD Protection	Human body model—±8kV (Air-gap discharge) &±4kV (Contact discharge)
Connections	
Transmitter	Inputs: 1x HDMI Type A [19-pin female] 1x VGA [15-pin female] 1x USB [USB-B] 1x IR IN [Phoenix jack] 1x RS-232 [Phoenix jack] 1×AUDIO IN [3.5mm Stereo Mini-jack] Outputs:1x HDBaseT Out [RJ45] 1x IR OUT [Phoenix jack]
Mechanical	
Housing	Plastic Enclosure
Color	White
Dimensions	91.8mm [W] x 104.8mm [D] x 43mm [H]
Weight	212.5g
Power Supply	Input: AC100 - 240V 50/60Hz Output: DC 24V/1A (US/EU standards, CE/FCC/UL certified)
Power Consumption	6W (Max)
Operating Temperature	32 - 104°F / 0 - 40°C
Storage Temperature	-4 - 140°F / -20 - 60°C
Relative Humidity	20 - 90% RH (no condensation)

5. Operation Controls and Functions

5.1 Front panel

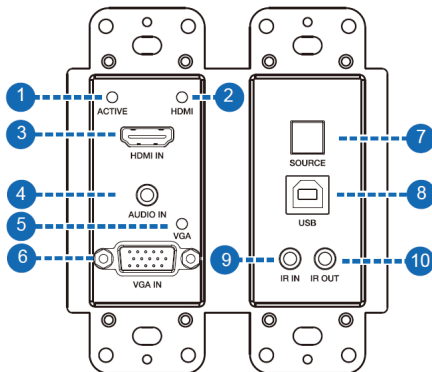

Number	Name	Function description
1	ACTIVE	Signal status indicator. The LED will illuminate green when the HDMI or VGA port has signal source input.
2	HDMI LED	The HDMI input signal indicator. The LED will illuminate green when the SOURCE button has selected the input signal from the HDMI port.
3	HDMI IN	Connect to HDMI source devices such as Blu-ray or PS4 player.
4	AUDIO IN	The VGA audio input port.
5	VGA LED	The VGA input signal indicator. The LED will illuminate green when the SOURCE button has selected the input signal from the VGA port.
6	VGA IN	The VGA input port.
7	SOURCE button	Manual switching button.
8	USB	USB host port.
9	IR IN	Receiving the remote-control signal and sending it to Receiver side
10	IR OUT	I am sending the remote-control signal from the Receiver side.

5.2 Rear panel

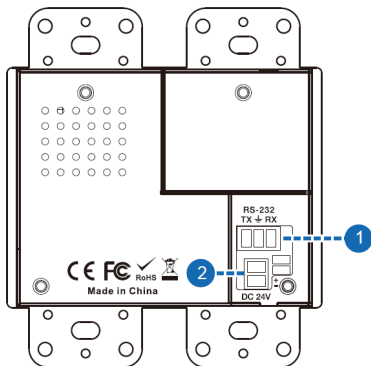

Number	Name	Function description
1	RS-232	Use the phoenix jack to connect the PC or control system to transmit RS-232 commands.
2	DC 24V	Use the phoenix jack to connect the power supply.

5.3 Side panel

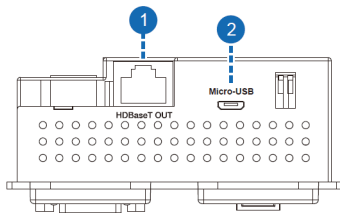

Number	Name	Function description
1	HDBaseT OUT	HDBaseT output port. Connect the HDBaseT receiver with a UTP cable.
2	Micro-USB	For firmware updates.

5.4 Dimension of Panel

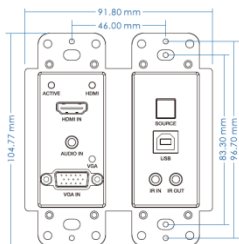

Figure 1 Front panel

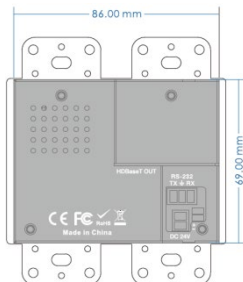

Figure 2 Rear panel

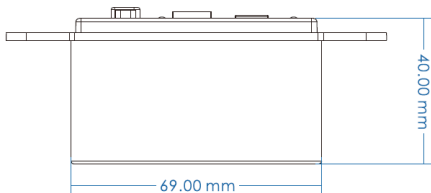
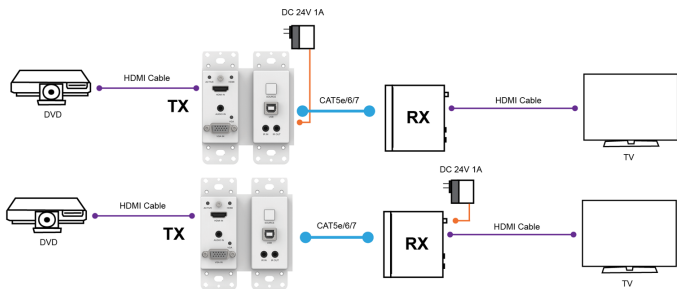
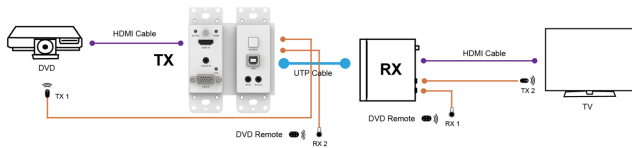

Figure 3 Side panel

※ Description 1 POC (Power over Cable) Application Example



※ Description 2 Bidirectional Infrared control Application Example



※ Description 3 Bidirectional RS-232 control Application Example

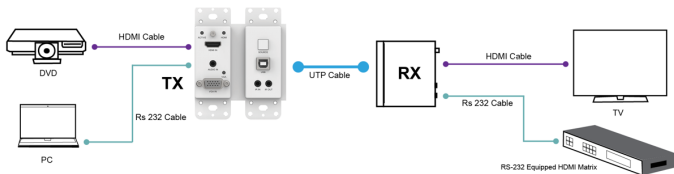

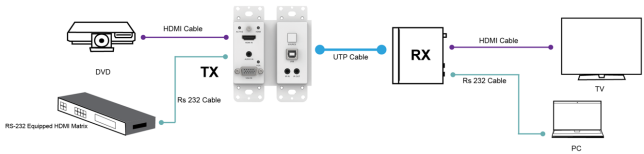

6. Application Example

